



MAESTRO 100EVO SERIES

QUICK START GUIDE & USER MANUAL REV. 0.2

WWW.MAESTRO-WIRELESS.COM

EMAIL: CONTACT@MAESTRO-WIRELESS.COM

TEL: 852 2869 0688

FAX: 852 2525 4701

ADDRESS: ROOM 3603-3609, 36/F, 118 CONNAUGHT ROAD WEST, SHEUNG WAN, HONG KONG



Revision history

Rev.	Date	Details	Originated by
0.1	11 August 2010	First release	Samuel Chereau
0.2	25 August 2010	Proof reading	Pierre-Emmanuel Surga

This manual is written without any warranty.

Maestro Wireless Solutions Ltd. reserves the right to modify or improve the product and its accessories which can also be withdrawn without prior notice.

Besides, our company stresses the fact that the performance of the product as well as accessories depends not only on the proper conditions of use, but also on the environment around the places of use.

Maestro Wireless Solutions Ltd. assumes no liability for damage incurred directly or indirectly from errors, omissions or discrepancies between the modem and the manual.

This software, solution or application is provided on an "as is" basis. No warranty whether expressed or implied is given by **Maestro Wireless Solutions Ltd.** in relation to this software, solution or application. User shall assume the entire risk of using or relying on this software, solution, application.

In no event will **Maestro Wireless Solutions Ltd.** be liable for any loss or damage including without limitation, indirect or consequential loss, damage, or any loss, damage whatsoever arising from loss of data or profit arising out of, or in connection with, the use of this software, application or solution. Every effort is made to keep the software, application or solution up and running smoothly. However, **Maestro Wireless Solutions Ltd.** takes no responsibility for, and will not be liable for, the software, application or solution being temporarily unavailable due to technical issues beyond our control.

The above terms and conditions are subject to change without prior notice. The present use of this software, application or solution implies the user approves and understands all the above terms and conditions.



Contents

1	M100evo easy setup guide	9
1.1	Download the M100evo configuration software	9
1.2	Use of the M100evo configuration software	9
1.2.1	COM port	9
1.2.2	Modem status	10
1.2.3	Network and Serial port	10
1.2.4	GPRS & TCP/IP connection	11
1.2.5	Call screening	11
1.2.6	Remote control	12
1.2.7	IP ping	12
1.2.8	TMODE	13
1.2.9	DOTA	13
1.2.10	Trigger I/O	14
2	Equipments Description	15
2.1	Package	15
2.2	Interfaces	15
2.2.1	Status indicator	15
2.2.2	SMA female antenna connector	16
2.2.3	15-Pin D-Sub Female connector (RS232/Audio)	16
2.2.4	4-Pin connector (Power input/output)	17
2.3	Optional accessories	17
3	Installation	19
3.1	Mounting the modem	19
3.2	Install the SIM card	19
3.3	Connect the external antenna (SMA type)	19
3.4	Connect the modem to external device	20
3.5	Connect the DC power supply	20

4	Default Settings	21
4.1	Factory settings	21
4.2	Input/Output port	21
4.3	Analog input port	22
4.4	RS232 Auto-online mode (power saving)	22
5	Troubleshooting	23
5.1	The modem's LED does not light	23
5.2	The modem's LED lights but does not blink long time after power up	23
5.3	The modem does not respond to the terminal program	23
5.4	No voice could be heard for the modem's speaker output when a call is answered	23
5.5	Debug, or further command using Microsoft Windows XP Hyper Terminal as example	24
5.6	Basic operations	26
6	Specifications	27

Safety precautions

General precautions

- The modem generates radio frequency (RF) power. When using the modem care must be taken on safety issues related to RF interference as well as regulations of RF equipment.
- Do not use your phone in aircraft, hospitals, petrol stations or in places where using GSM products is prohibited.
- Be sure that the modem will not be interfering with nearby equipment. For example: pacemakers or medical equipment. The antenna of the modem should be away from computers, office equipment, home appliance, etc.
- An external antenna must be connected to the modem for proper operation. Only used approved antennas with the modem. Please contact authorized dealer on finding an approved antenna.
- Always keep the antenna with minimum safety distance of 26.6cm or more from human body. Do not put the antenna inside metallic box, containers, etc.

Using the modem in vehicle

- Check for any regulation or law authorizing the use of GSM in vehicle in your country before installing the modem
- Install the modem by qualified personnel. Consult your vehicle dealer for any possible interference of electronic parts by the modem.
- The modem should be connected to the vehicle's supply system by using a fuse-protected terminal in the vehicle's fuse box
- Be careful when the modem is powered by the vehicle's main battery. The battery may be drained after extended period.

Protecting your modem

To ensure error-free usage, please install and operate your modem with care. Do remember the following:

- Do not expose the modem to extreme conditions such as high humidity/rain, high temperatures, direct sunlight, caustic/harsh chemicals, dust, or water.
- Do not try to disassemble or modify the modem. There is no user serviceable part inside and the warranty would be void.
- Do not drop, hit or shake the modem. Do not use the modem under extreme vibrating condition.
- Do not pull the antenna or power supply cable. Please attach or detach by holding the connector.
- Connect the modem only according to the instruction manual. Failure to do it will void the warranty



Chapter 1

M100evo easy setup guide

Maestro 100evo series is a range of ready-to-use GSM modems for voice, data, fax and SMS services. It also supports GPRS Class 10 for packet mode data transfer. The M100evo is easily controlled by using AT command for all kinds of operations. Fitted with a standard fifteen pins RS232 port and telephone-like audio plug (via optional Y-cable) the M100evo can be set up with minimal effort. The M100evo modem also features a digital input/output pin and an analog input pin.

1.1 Download the M100evo configuration software

Start your web browser and download the M100evo configuration software at this address: <http://www.maestro-wireless.com/software/>.

Please extract the .rar file and start the setup.exe application. Follow the instructions on screen to install the software. It will also create a shortcut on your desktop.

1.2 Use of the M100evo configuration software

Note: For more details on each AT command, parameters and feature of the modem please refer to the software manual rev. 0.95.

1.2.1 COM port

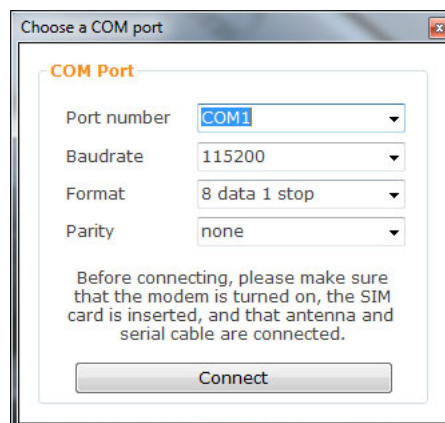

This window will appear when the application starts, you need to enter your COM port settings. Default settings are the factory settings of the M100evo.

1.2.2 Modem status



After an automatic serial connection check, the Modem Status tab will appear. It displays the reception signal strength (RSSI, refreshed every five seconds), your SIM card network name, as well as the revision number for the embedded application and firmware.

1.2.3 Network and Serial port

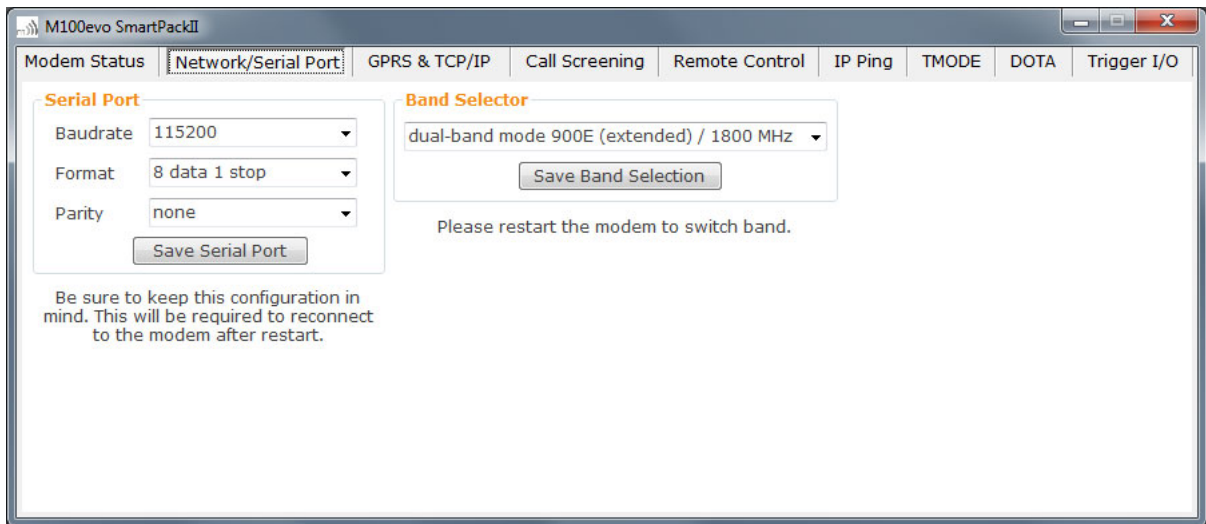

In this second tab you can change all the settings of the serial port, and GSM network bands..

Note: To reboot your modem just unplug the power supply cable, and plug it back.

Note: After changing your serial port settings you will have to restart the configuration software with the new COM interface parameters.

1.2.4 GPRS & TCP/IP connection

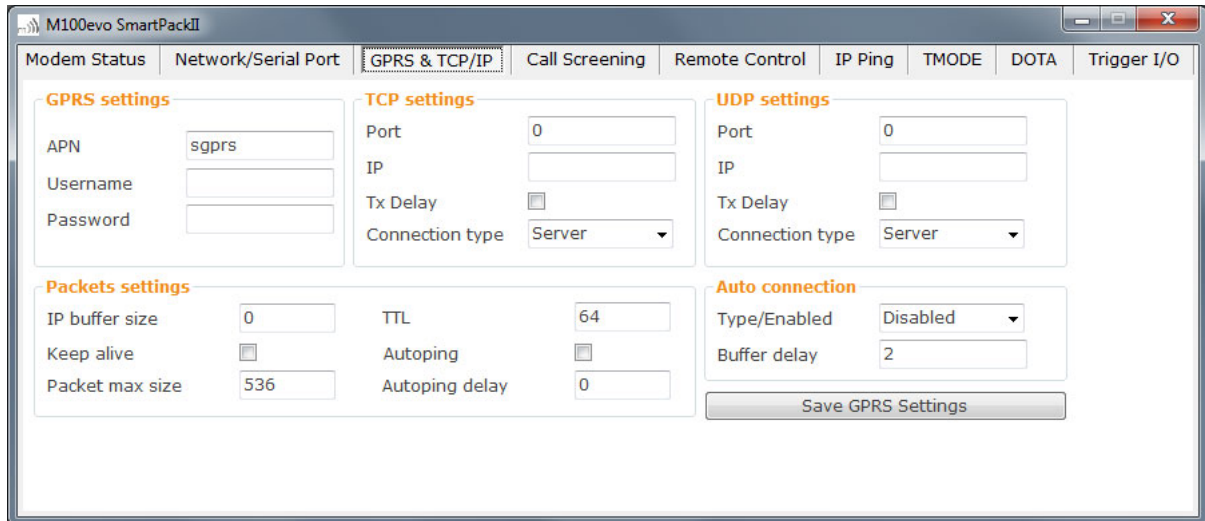

In this tab you will be able to setup most of the GPRS-related features of the SmartPackII. The most important is the APN (access point name, which is provided by your network operator). For more details on each features please refer to the SmartPackII software manual. This tab is also used to setup automatic TCP/UDP connection to a remote server, or as a server.

Note: All the other values in here are default values.

1.2.5 Call screening



This tab lets you set the call screening settings, which allows you to filter the incoming call to your modem up to 10 phone numbers.

Note: Input the number with + for the country code. Example: +85298635152 for a Hong Kong number.

1.2.6 Remote control

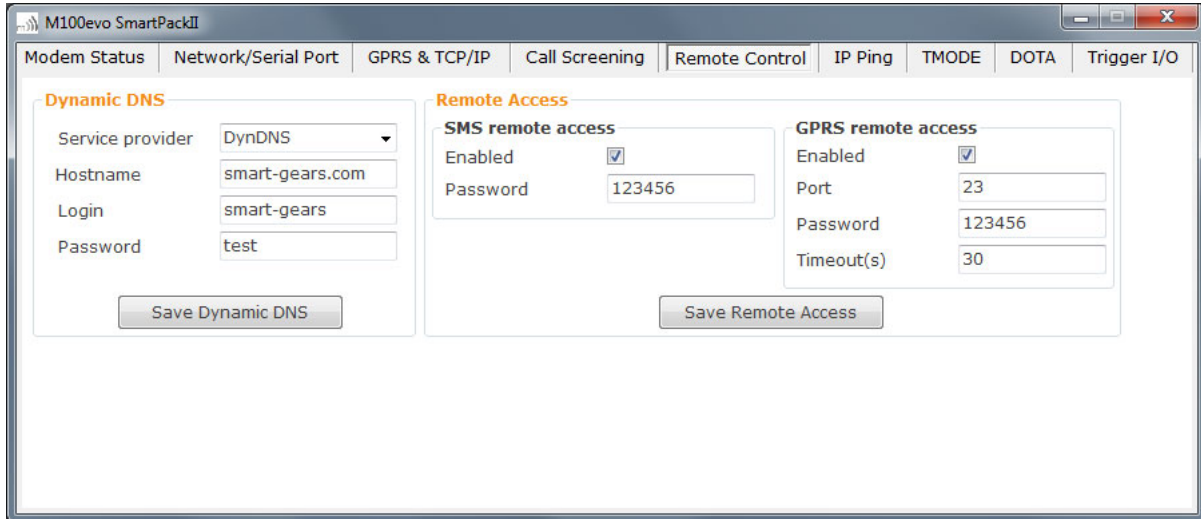

This tab allows you to setup your Dynamic DNS account, and the remote access settings for your modem. These functions give you a way to remotely configure and diagnostic your modem, by sending AT commands over SMS or GPRS (telnet mode).

For more details, please refer to the SmartPackII software manual.

1.2.7 IP ping

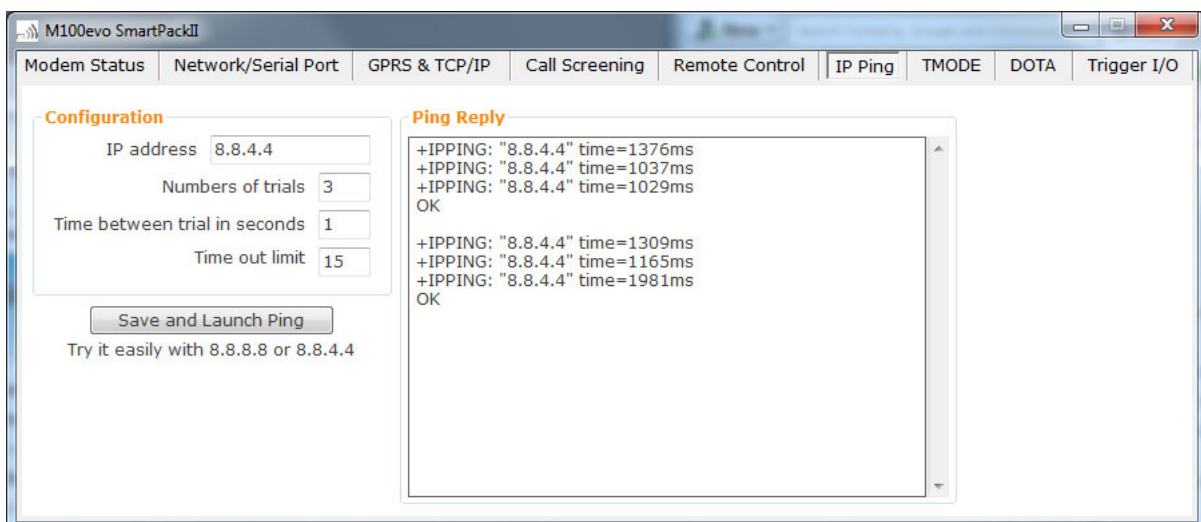

This tab allow you to ping an IP address on the Internet, for test and debug purpose. It is designed to give you a quick way to verify the GPRS data parameters.

1.2.8 TMODE

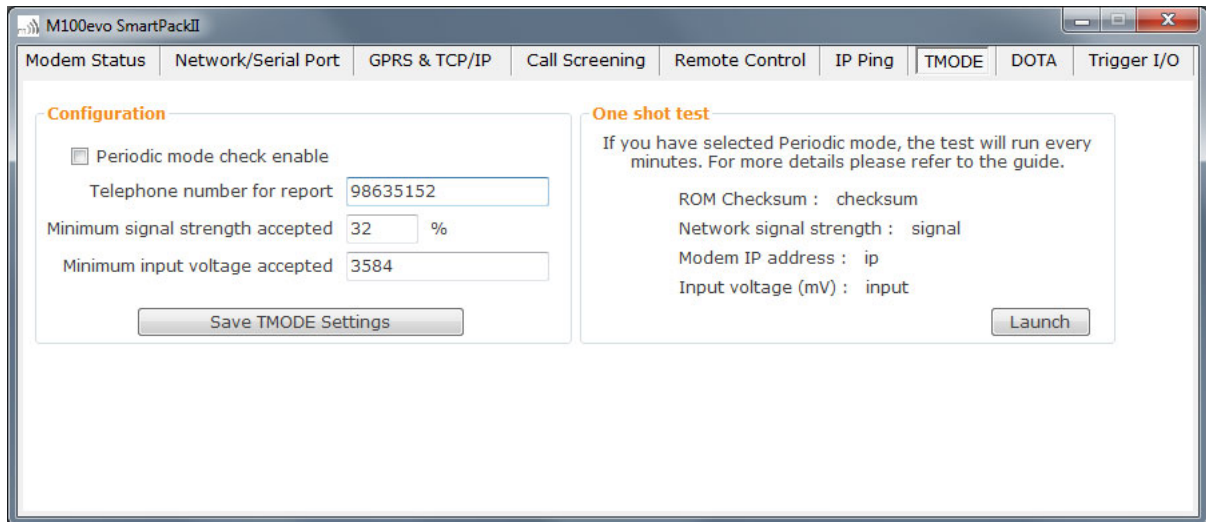

This tab is for the SmartPackII Tmode that allow to check your modem ROM, signal strength, IP address and module input voltage, and send alert by SMS if values exceed a treshold.

1.2.9 DOTA

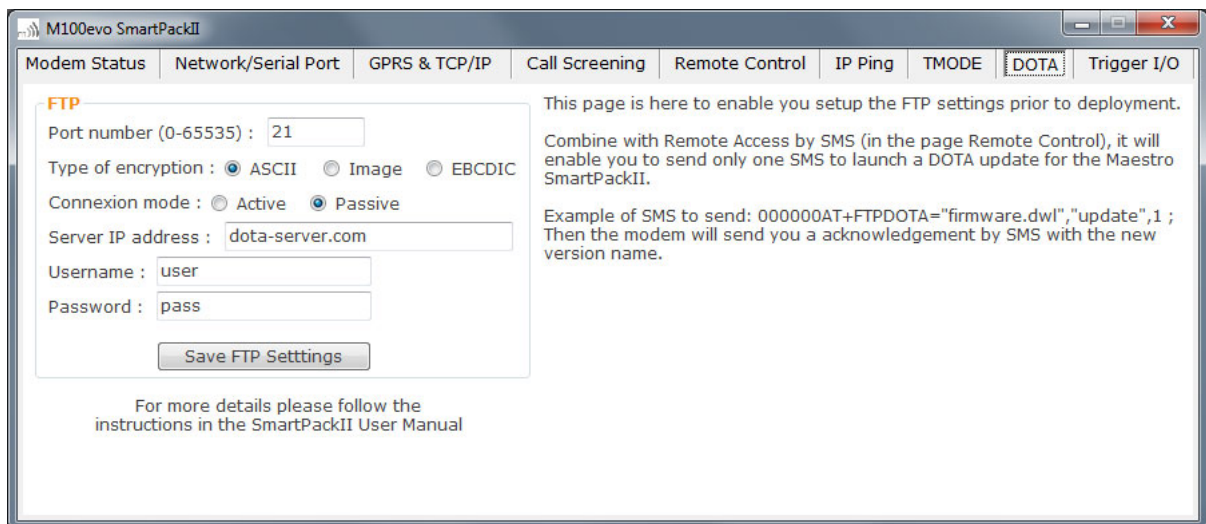

This tab allow you to setup your FTP server for over the air embedded application update. The actual update process is triggered by a SMS or an AT command sent remotely (see the remote control tab).

1.2.10 Trigger I/O

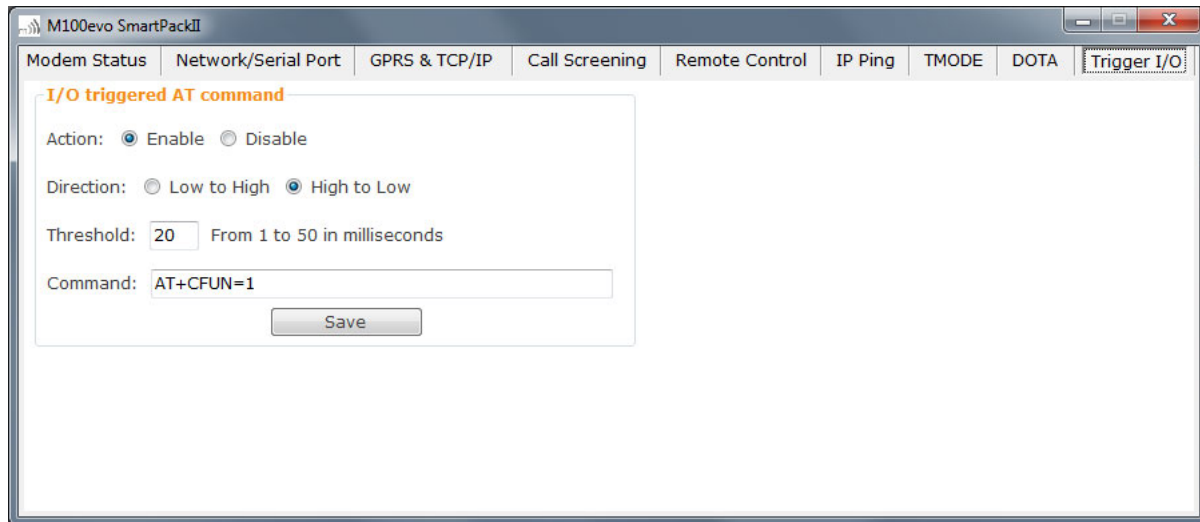

The M100evo features one digital I/O. Using this function, you can have any AT command triggered when a digital signal is received on this digital input.

Chapter 2

Equipments Description

2.1 Package

The M100evo package includes the following:

- M100evo modem x 1
- Power cord with fuse x 1
- Safety note x 1

2.2 Interfaces

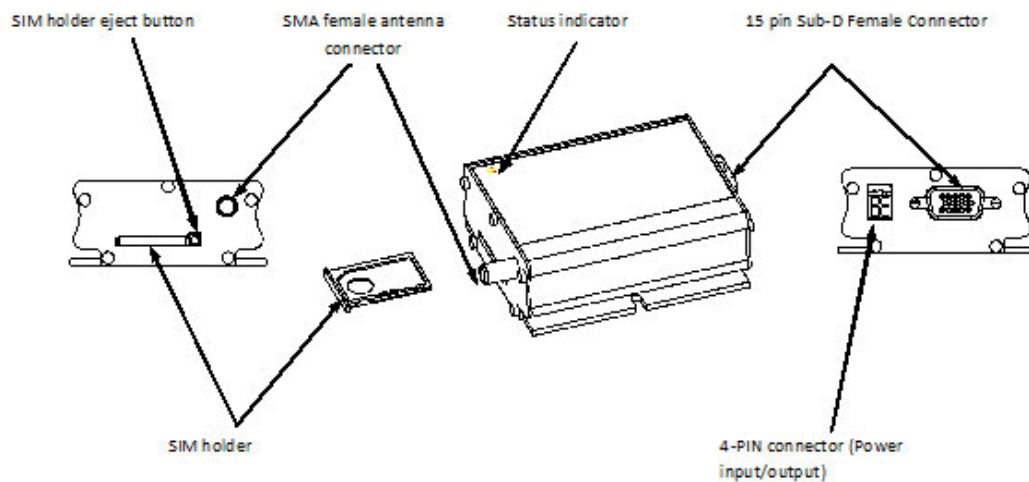

2.2.1 Status indicator

The LED will indicate different status of the modem:

- OFF: modem is switched off
- ON: modem is connecting to the network
- Flashing slowly: modem is in idle mode
- Flashing rapidly: modem is in transmission/communication (GSM only)

2.2.2 SMA female antenna connector

Connect this to an external antenna with SMA male connector. Make sure the antenna is for the correct GSM frequency with impedance of 50 Ohm, and also that the connector is tightly secured.

2.2.3 15-Pin D-Sub Female connector (RS232/Audio)

This connector provides serial link and audio link to the modem.

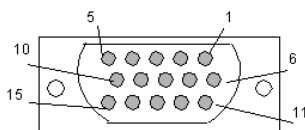

Pin Number	Name	EIA designation	Type	Note
1	DCD	Data Carrier Detect	Output	
2	TX	Transmit Data	Input	
3	BOOT		Input	Not used
4	MICROPHONE +		Input	With 2VDC bias output
5	MICROPHONE -		Input	With 2VDC bias output
6	RX	Receive Data	Output	
7	DSR	Data Set Ready	Output	
8	DTR	Data Terminal Ready	Input	
9	GND	Ground	Ground	
10	SPEAKER +		Output	
11	CTS	Clear To Send	Output	
12	RTS	Request To Send	Input	
13	RI	Ring Indicator	Output	
14	RESET		Input	Pull low to reset
15	SPEAKER -		Output	

Specification of microphone and speaker to be connected:

Parameters	Min	Typical	Max
Microphone current @2V/2K Ohm		0.5mA	
Microphone input level			100mVpp
Speaker output current 150 Ohm/1nF		16mA	
Speaker impedance	32 Ohm	50 Ohm	

Please refer to the document "Application notes - Power supply & Audio" for more information about audio connection.

2.2.4 4-Pin connector (Power input/output)

A cable, included in the package shall be used for power supply connection:

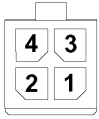

Pin assignment of 4-Pin connector:

Pin number	Name	Functions
1	ADC	Analog input
2	GPIO	General purpose I/O
3	POWER -	DC power negative input (or ground)
4	POWER +	DC power positive input

The power cable included in the package shall be used for power supply connection:

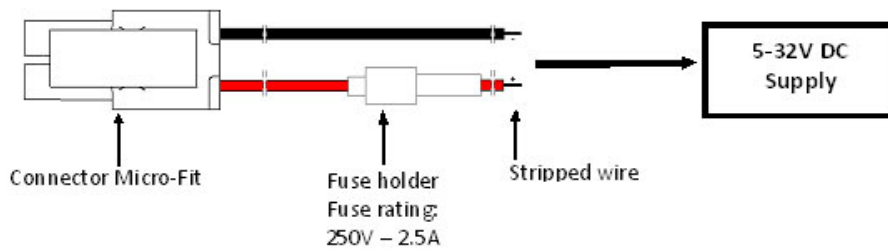

2.3 Optional accessories

You may contact your sales agent for the following optional accessories:

External antenna



- Magnetic mount type
- Frequency GSM 900/1800 band
- Gain 3db
- VSWR < 1.5:1
- Height ~ 236 mm (including magnetic base)
- Cable: Type RG-174U length 2.5m

'Y' cable

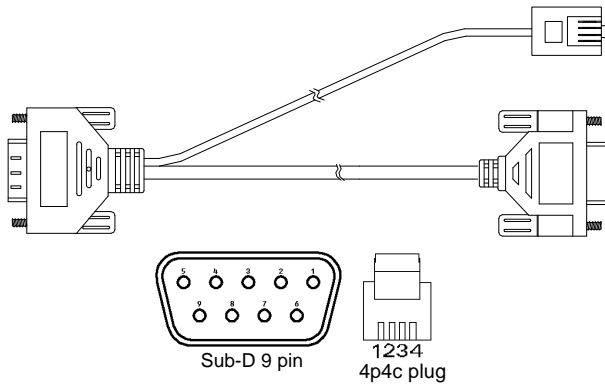

- Direct connection with standard 9-pin RS-232 port (DTE)
- Direct connection with common handset of telephone for voice call
- Shielded cable
- Cable length 1.1m (w/connector)

Pin assignment:

Sub-D 15 (male)	Sub-D 9 (female)	Plug 4P4C
1	1	
2	3	
3		
4		1
5		4
6	2	
7	6	
8	4	
9	5	
10		2
11	8	
12	7	
13	9	
14		
15		3

DIN rail mount

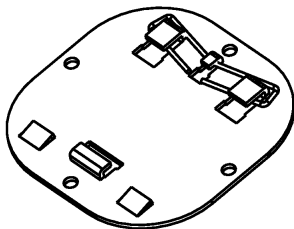

- Quick attachment / detachment to standard 35mm DIN rail
- Zinc plated steel

Chapter 3

Installation

3.1 Mounting the modem

Use 2 pieces of M3 screw to mount the modem on the DIN rail mount. Please refer to document "Installation of DIN rail mount" for details.

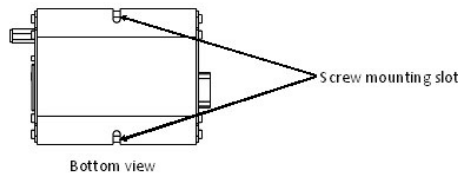

3.2 Install the SIM card

Use a ball pen or paper clip to press the SIM holder eject button. The SIM holder will come out a little. Then take out the SIM holder.

Note: DO NOT pull out the SIM holder without pushing the ejector button.

Put the SIM card to the tray; make sure it has completely sat on the tray. Put back the tray into the slot.

3.3 Connect the external antenna (SMA type)

Connect this to an external antenna with SMA male connector. Make sure the antenna is for the GSM frequency with impedance of 50 Ohm, and also connector is secured tightly.

Note: Please use antenna designed for GSM device operation. Incorrect antenna will affect communication and even damage the modem.

Note: Please respect a safety distance of at least 26.6cm to the antenna during the modem operation.

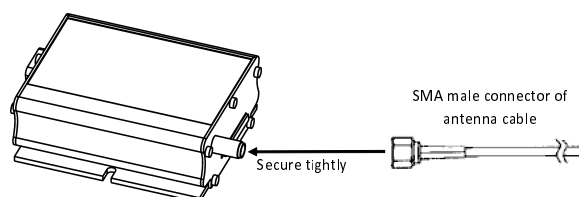

3.4 Connect the modem to external device

You can use the optional 'Y' cable to connect the modem's Sub-D connector to external controller/computer, or use the DB15 to DB9 conversion dongle provided by Maestro.

Note: The modem CANNOT be directly connected to the 'LINE' jack of a land-line telephone. It is not a foreign exchange station.

Connection example using optional 'Y' cable:

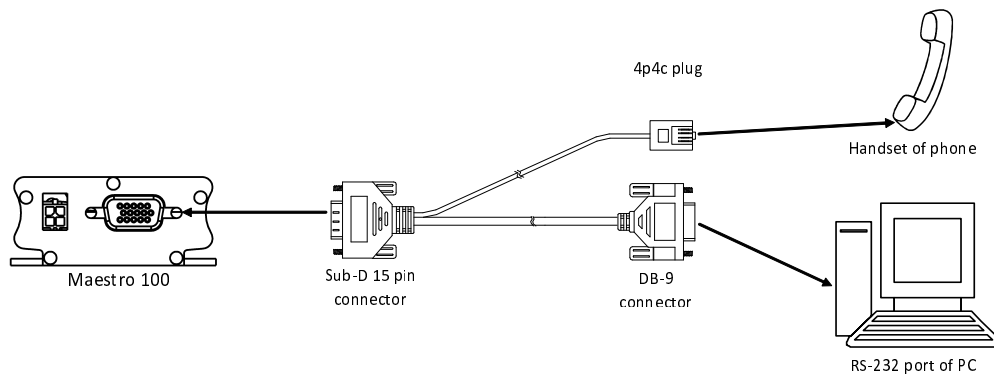

3.5 Connect the DC power supply

Connect the open ending of the provided power cord to a DC supply. Refer to the following for power supply requirement:

- Input voltage range : 5-32V
- Rated current: 650mA

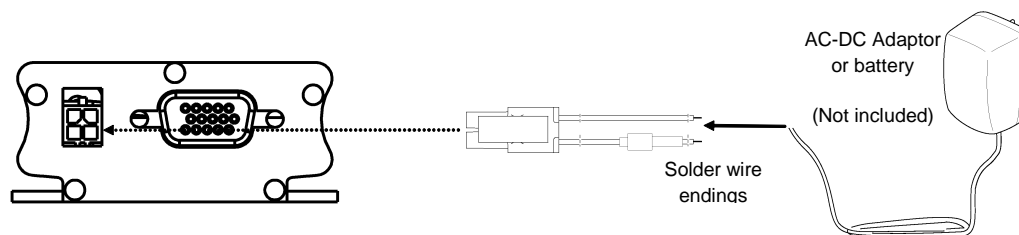

Plug the molex ending of the power cable to the modem DC connector.

The modem will turn on automatically. The status indicator on the modem will be lit when power on. After a few seconds it will go flashing slowly (registered to the network successfully refer 1.2.1)

Chapter 4

Default Settings

4.1 Factory settings

The modem has the following factory settings. Please refer to the AT command document for the meaning of each setting.

Related AT commands	Factory settings	Description
AT+IPR	115200	DTE-DCE data rate
AT+IFC	2,2	DTE-DCE flow control
AT+ICF	3,4	DTE-DCE character framing
ATE	1	ECHO
AT&C	1	DCD signal
AT&D	2	DTR signal
ATQ	0	Result code suppression
ATV	1	Response format
AT&S	1	DSR signal
ATS0	0	Auto answer
AT+CLIP	0	Calling line ID presentation
AT+CRLP		Calling line ID restriction
AT+CSCS	"PCCP437"	Character Set
AT+CMGF	1	Short message format
AT+CSMP	1,67,0,0	Test mode parameters*
AT+CNMI	0,1,0,0	New message indication*

***Note:** settings stored in SIM, not in modem

4.2 Input/Output port

This port can be configured as either an input one or an output one.

The port is mapped to GPIO26 on the internal micro-controller.

To setup this port as an input, type AT+WIOM=1,"GPIO26",0 on the serial port. Then you can read the status of the input with AT+WIOR="GPIO05". +WIOR: 0 means 0V while +WIOR: 1 means a positive voltage of no more than 2.8V. Higher voltages may damage the M100evo.

To setup this port as an output, type AT+WIOM=1,"GPIO26",1 on the serial port. Then you can set the status of the output with AT+WIOW="GPIO26",0 for 0V, AT+WIOW="GPIO26",1 for 2.8V.

4.3 Analog input port

This port can be used either as a voltage input (0-5V range) or as a current input (0-20mA range). To setup the port as a voltage input, issue the following commands: `AT+WIOM=1,"GPIO19",1` then `AT+WIOW="GPIO19",0`. For a current input, issue: `AT+WIOM=1,"GPIO19",1` then `AT+WIOW="GPIO19",1`.

To read the value of the input, use the command `AT+ADC?`. More information can be found in the AT commands interface guide document.

4.4 RS232 Auto-online mode (power saving)

When being in the auto-online, the RS232 transceiver will shut down most of its hardware to save power if it does not detect a valid input for more than 100uS. The RS232 transceiver will wake up when valid input is detected again.

By default, the RS232 transceiver is put in auto-online. This mode can be turned off by issuing `AT+WIOM=1,"GPIO25",1` then `AT+WIOW="GPIO26",1`.

Chapter 5

Troubleshooting

5.1 The modem's LED does not light

- Check if the modem has been properly connected to a 5-32V power supply
- Check if the power connector is properly inserted
- Check the fuse on the power cord

5.2 The modem's LED lights but does not blink long time after power up

- Check if a valid SIM card has been properly inserted
- Check if the SIM card has been locked (refer to AT+CPIN command in AT command guide)
- Check if the external has been properly connected to the modem
- Check if the network coverage is available

5.3 The modem does not respond to the terminal program

- Check if the RS232 cable has been properly connected
- Check if your program has proper settings. Factory setting of the modem is:
 - 115200 bps
 - 8 data bits
 - No parity bit
 - 1 stop bit 4.

5.4 No voice could be heard for the modem's speaker output when a call is answered

- Make sure a voice call has been made (refer to AT command guide)
- Enter the AR+SPEAKER=1 command

5.5 Debug, or further command using Microsoft Windows XP Hyper Terminal as example

1. On the first time power-up you can use terminal software to communicate with the modem through an RS232 serial port. Following example is using the Hyper Terminal in Windows XP.

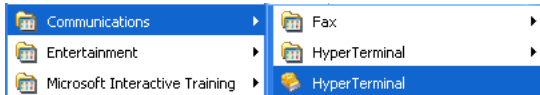

- 2.
3. On Windows XP, start the Hyper Terminal program. Assign a name for a new session.

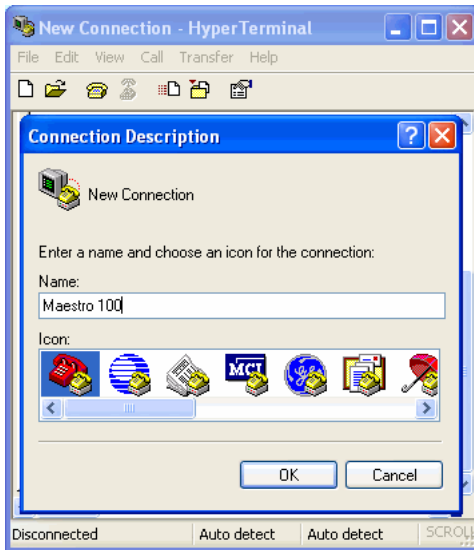

- 4.
5. Choose the correct Com port and baud rate settings (115200bps, 8bits, no parity bit, 1 stop bit)

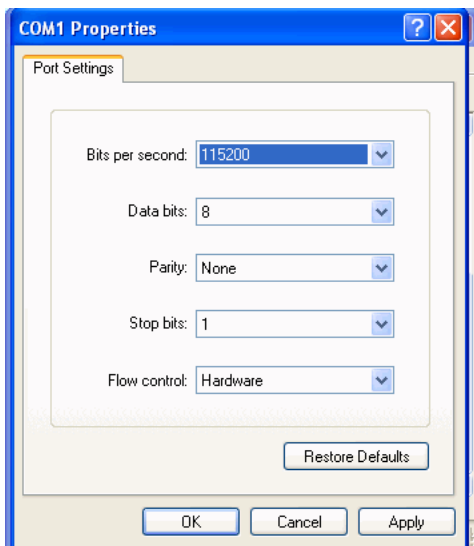

- 6.

7. On the terminal screen, type "AT" to check the "OK" response from the modem

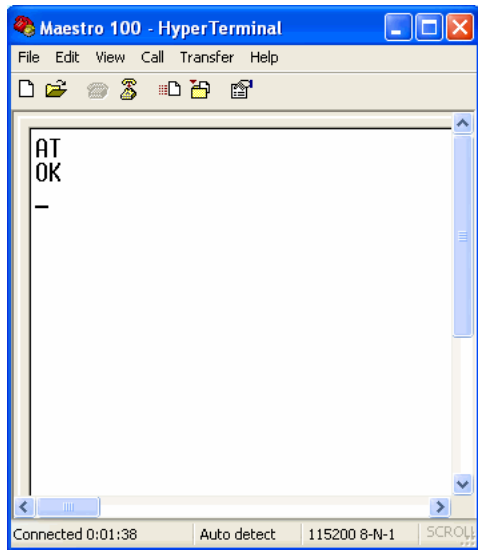

- 8.

5.6 Basic operations

Followings are examples of some AT commands. Please refer to the AT command document for a full description.

Note: Issue AT+CMEE=1 to have extended error code (+CME ERROR)

Description	AT commands	Modem response	Comments
Network registration checking	AT+CREG?	CREG=<mode>,1	Modem registered to the network
		CREG=<mode>,2	Registration lost, re-registration attempt
		CREG=<mode>,0	Modem not registered on the network, no registration attempt
Receiving signal strength	AT+CSQ	+CSQ:20,0	The first parameter has to be at least 15 for normal communication
Receiving an incoming call		RING	An incoming call is waiting
	ATA	OK	Answer the call
Make a call	ATD1234567;	OK	Communication established (Don't forget the ";" at the end for "voice" call)
		+CME ERROR: 11	PIN code not entered (with +CME=1 mode)
		+CME ERROR: 3	AOC credit exceeded or a communication is already established
Make an emergency call	ATD 112;	OK	Communication established (Don't forget the ";" at the end for "voice" call)
Communication loss		NO CARRIER	
Hang up	ATH	OK	
Enter PIN code	AT+CPIN=1234	OK	PIN Code accepted
		+CME ERROR: 16	Incorrect PIN code (with +CME=1 mode)
		+CME ERROR: 3	PIN already entered (with +CME=1 mode)
Saves parameters in non-volatile memory	AT&W	OK	The configuration settings are stored

Chapter 6

Specifications

- Quad Band GSM 850 / 900 / 1800 /1900 MHz
- Support Data, SMS, Voice and Fax
- Max power output: 2W(900MHz), 1W(1800MHz)
- Group 3 FAX support (Class 1 and 2)
- GPRS Class B class 10 (4Rx+1Tx or 3Rx+2Tx) at maximum speed *
- SIM Tool Kit Class 2
- AT command set (GSM 07.05, GSM 07.07 and Sierra Wireless proprietary)

***Note:** available slot for GPRS connection is network dependent.

Power supply requirement:

- Input voltage range : 5-32V
- Rated current: 650mA

Typical current consumption:

	@5V	@12V	@32V
GSM850/900 communication mode PCL=5	203mA	104mA	39mA
DCS1800 PCS1900 communication mode PCL=0	150mA	71mA	30mA
GPRS 850/900 2 Tx @ Gamma 3	388mA	162mA	64mA
GPRS1800/1900 2 Tx @ Gamma 3	232mA	110mA	45mA
Idle mode	45mA	25mA	12mA
Idle mode (RS232 not connected)	18mA	12mA	6mA

Interfaces:

- SIM Holder
- 15 pin sub-D connector
- 4 pin power supply connector
- SMA antenna connector (50Ohm)

Dimensions:

- Overall size: 88mm x 60mm x 26mm
- Weight: 100g
- Temperature range:
 - Operating: -30°C to +75°C
 - Storage: -40°C to +85°C